

HAMPTON BAY®

Specification Guide ▪ January 2025



Sinclair Collection
Finish Shown in Light Oak

Wall Cabinet Construction

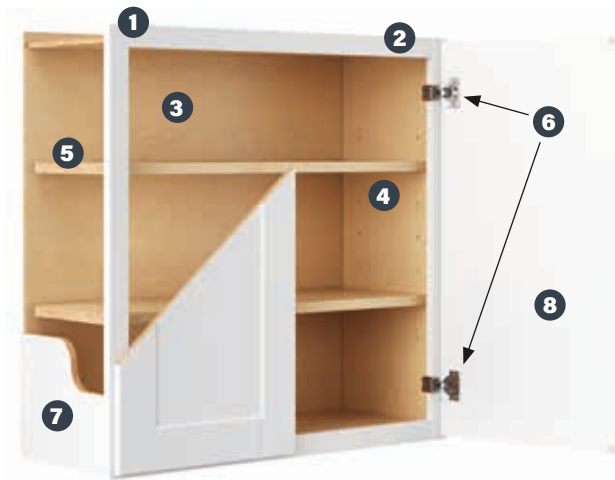

- 1 **Top/Bottom Panels:** 3/8" thick engineered wood fully encapsulated in the face frame, back and side panels.
- 2 **Face Frame:** Pocket screw construction with 3/4" thick, 11/2" wide material.
- 3 **Back Panel:** 3/8" thick engineered wood fully encapsulated into top and bottom panels for strength.
- 4 **Interior:** Natural maple laminate finish.
- 5 **Full-Depth Shelf:** 3/4" thick engineered wood with metal shelf pins.
- 6 **Hinges:** Fully concealed and adjustable.
- 7 **End Panels:**
Finished Cabinetry - 1/2" thick engineered wood with laminated exterior to match cabinet finish.
Unfinished Cabinetry - 1/2" thick engineered wood with raw exterior.
- 8 **Door:** Single-door cabinets are hinged left and can be reversed in the field. No center stiles on double-door cabinets to allow full access.

Base Cabinet Construction



- 1 **Drawer Glides:**
Finished Cabinetry - Ball-Bearing
Unfinished Cabinetry - Epoxy
- 2 **Drawer Box:** Hardwood 4-sided drawer box with fully encapsulated bottom panel.
- 3 **Bottom Panel:** 3/8" engineered wood fully encapsulated in the face frame, back and side panels.
- 4 **Face Frame:** Pocket screw construction with 3/4" thick, 11/2" wide material.
- 5 **Back Panel:** 3/8" thick engineered wood. Backs of sink base cabinets must be cut for plumbing access.
- 6 **Interior:** Natural maple laminate finish.
- 7 **Half-Depth Shelf:** 3/4" thick engineered wood.
- 8 **Hinges:** Fully concealed and adjustable.
- 9 **End Panels:**
Finished Cabinetry - 1/2" thick engineered wood with laminated exterior to match cabinet finish.
Unfinished Cabinetry - 1/2" thick engineered wood with raw exterior.
- 10 **Door:** Single-door cabinets are hinged left and can be reversed in the field. No center stiles on double-door cabinets to allow full access.

Hampton Bay® Kitchen Programs

1. In-Stock – Take cabinets home today
 - Essential cabinet selection for most kitchens
 - Finish availability varies by store
2. Special Order – Ships to the store in 2 weeks
 - Expanded cabinet selection, ships free to store with 5 cabinet minimum
 - All door styles and finishes available
3. HomeDepot.com
 - Expanded cabinet selection, ships next day to the store, home or jobsite
 - Free delivery to the store
 - All styles and finishes available
4. PRO Program – Ships direct to the home or jobsite within 2-3 weeks
 - Includes all stock and Special Order cabinets and accessories
 - Volume discounts available at 75+ cabinet and 150+ cabinets
 - No order minimum on Quote Center orders
 - All door styles and finishes available



75+ cabinet sizes available in all finishes

SHIPS NEXT DAY

on homedepot.com orders

2020 Catalogs

When designing with the Hampton Bay offering, use the below listed 2020 catalogs:
 HBK_SK: In-Stock Pick List for Finished and Unfinished Cabinetry
 HBK_SO: Special Order for all Finished and Unfinished Cabinetry

Special Order Processing

Special order Hampton Bay cabinet orders ship in 2 weeks. Some orders and store locations, including those outside the Continental U.S., may require more delivery time.

- Orders placed before 3:00 pm EST M-F will be recognized at the end of the same business day
- Orders placed after 3:00 pm EST M-F will be recognized the next business day
- Orders placed after 3:00 pm EST F-Sun will be recognized on Monday (if not a holiday)
- Holidays are NOT included in the 2 week lead-time
- A five cabinet minimum applies to all Hampton Bay Special Orders - accessories are not included in the five cabinet minimum

RTV Procedures

Hampton Bay Special Order (Vendor # 60071203) and In-Stock (Vendor # 71203):

- Carrier Damage – If damage occurs during transit, the Receiving Department must file a freight claim with the Home Depot authorized carrier. Special Order product should be reordered for customer as needed (see "Replacement and Add-On Orders" bullet below).
 - ▶ The store determines whether the product can be sold with a markdown, donated or field destroyed.
- Manufacturer Defect – If a product contains a manufacturing or product defect, the Receiving Department should process the product using an RGA (see "Returns" bullet below). Product should be reordered for customer (see "Replacement and Add-On Orders" bullet below).
- Incorrect Product – If you believe that incorrect product was received, please contact Customer Care at (888) 578-4009.
- Replacement and Add-On Orders – When placing a replacement order or add-on order to complete an existing job, reference the original PO in the 2020 notes field otherwise orders will not be processed if the order falls under the (5) five cabinet order minimum.
- Returns – For all returns, regardless of reason, the Receiving Department should assign an RTV tag and utilize their department's First Phone to gain an RGA.
 - ▶ All returned product should be destroyed in field regardless of RTV code.
- Cancellation – Hampton Bay Customer Care will not allow cancellations or changes to orders after 24 hours from receipt of the PO from the store. All cancellation requests must be submitted by email from the store to homeproducts_CC@woodmark.com in order to receive a cancellation number. A purchase order is not cancelled until a cancellation number has been issued.
- Additional Questions – Please contact Customer Care at (888) 578-4009 with any additional questions.

Program Overview	1
Wood Characteristics and Overlay Styles	2
Door Styles and Finishes	3
Frame Opening Dimensions and Ceiling Height Requirements	4
Installation Height Guidelines	5
Model Number Guide	6
Wall Cabinets	7-9
Base Cabinets	10-13
Vanity Cabinets	14
Pantry and Oven Cabinets	15
Accessories, Panels and Moldings	16-21
Warranty	22
Important Information	23

Wood Characteristics

All wood species will exhibit color changes when exposed to different types of light and environments over time. Such color changes are expected in Hampton Bay brand cabinetry and are not defects. Graining differences, mineral streaks and color variations are expected and part of the unique natural beauty in wood cabinetry. Hampton Bay wood cabinet door styles often exhibit these characteristics and are not defects. Hampton Bay may, at times, use various wood species including, but not limited to, those listed below. Understanding the characteristics typical of these species can help establish realistic expectations.

- Maple:** Maple wood inherently has a characteristic known as "birdseye" or "fiddleback" pattern in the wood. When finished, it can have the appearance of a varied sheen, a splotchy appearance, or satiny look. This is the beauty of real maple and not a defect. In most cases it takes on a very pleasant look. Mineral streaks are also common and may appear darker when stained.
- Oak:** Oak is an open-grained hardwood with varying patterns ranging from straight grain to wide arcs. When stained, there will be a noticeable difference in the color shades between the open and closed grain areas of the wood. Wood can range from pink to a reddish brown.
- Hickory:** Hickory is a heavy hardwood which when finished has a warm, appealing appearance. Distinctive color streaks, combined with knots and other noticeable characteristics, make for a rustic appearance. While some parts may be clear and others extremely rustic, the characteristics of hickory are an inherent part of its charm and are considered to be a desirable part of the total look.
- Beech:** Beech wood is typically a pale cream color that turns into a pink to reddish tone due to a light steaming process that occurs during kiln drying. Small pin knots can be found in small clusters and is a normal occurrence in the wood. Grain appears tightly closed and may have some slightly darker spots of redheart within the sapwood which gives depth and character to beech wood.
- RTF:** Rigid Thermofoil (RTF) is composed of a vinyl laminate that is bonded to MDF (medium-density fiberboard) surface with high heat and pressure, resulting in a beautiful and durable product that last for years.

Overlay Styles and Dimensions

The drawings shown below illustrate the relationship between the cabinet face frame and Traditional Overlay, Full Overlay and Traditional Overlay (Unfinished) doors. They show the amount of the cabinet face frame that is visible for each overlay.

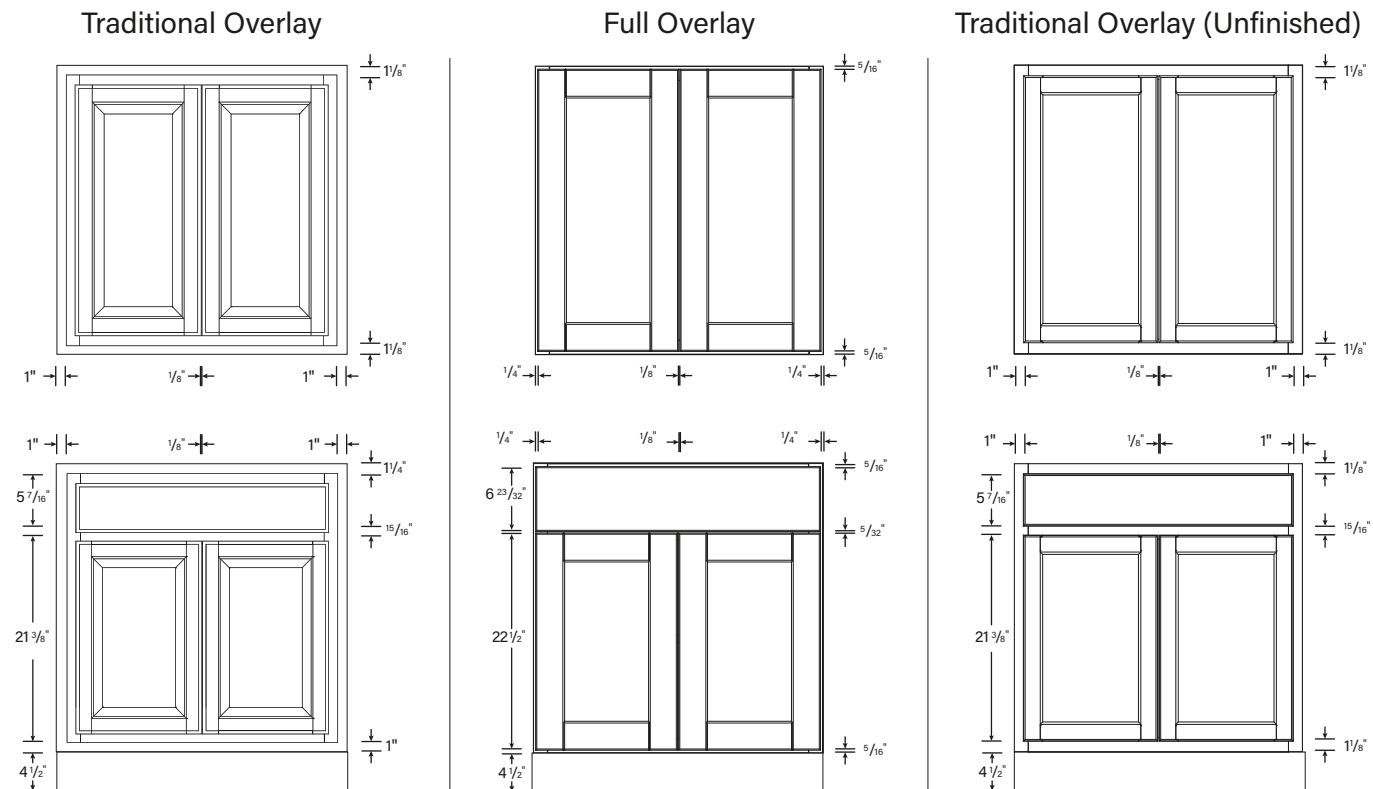

Shaker

DOOR STYLE DETAILS

- Door Frame:** Mortise and Tenon
- Center Panel:** Recessed
- Overlay:** Full Overlay

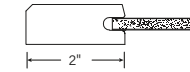
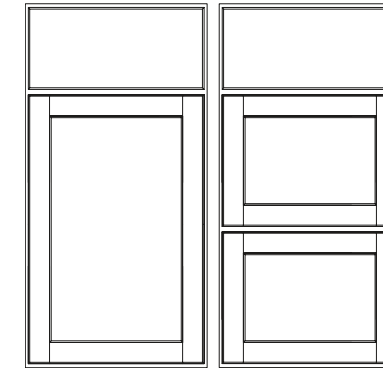

FINISH	CODE
Java	SJM

Sinclair

DOOR STYLE DETAILS

- Door Frame:** Mortise and Tenon
- Center Panel:** Recessed
- Overlay:** Full Overlay

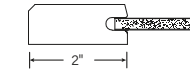
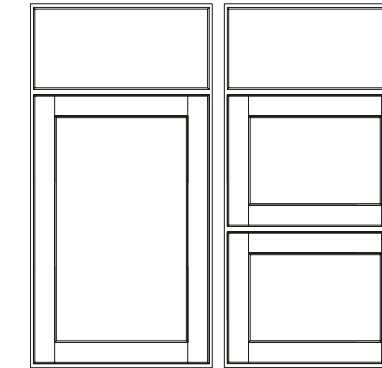

FINISH	CODE
Light Oak	SLO
Saddle Oak	SSB

Shaker (RTF)

DOOR STYLE DETAILS

- Door Frame:** Routed MDF
- Center Panel:** Recessed
- Overlay:** Full Overlay

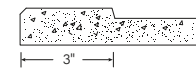
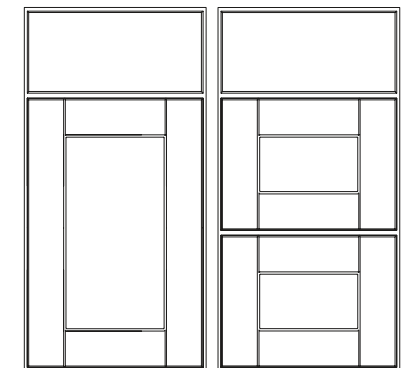

FINISH	CODE
Satin White RTF	SSW
Dove Gray RTF	SDV

Hampton

DOOR STYLE DETAILS

- Door Frame:** Mortise and Tenon
- Center Panel:** Raised
- Overlay:** Traditional Overlay

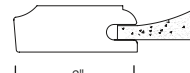
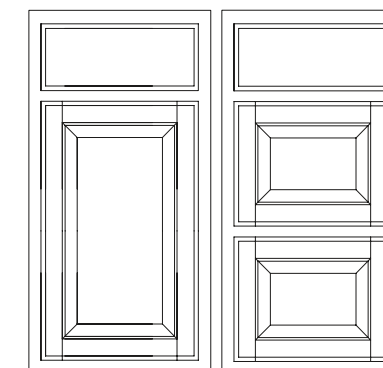

FINISH	CODE
Natural Hickory	NHK
Medium Oak	MO

Hampton (RTF)

DOOR STYLE DETAILS

- Door Frame:** Routed MDF
- Center Panel:** Raised
- Overlay:** Full Overlay

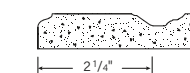
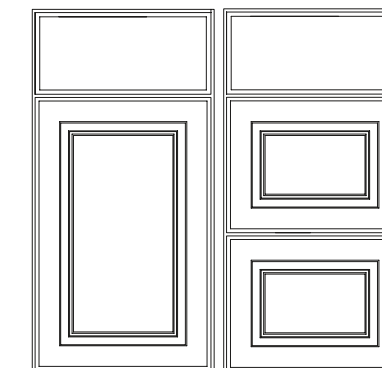

FINISH	CODE
Satin White RTF	SW

Unfinished

DOOR STYLE DETAILS

- Door Frame:** Mortise and Tenon
- Center Panel:** Recessed
- Overlay:** Traditional Overlay

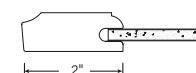
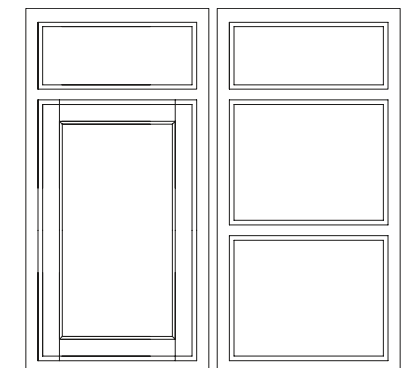

FINISH	CODE
Unfinished	UF

Frame Opening Dimensions

These illustrations specify dimensions of standard interior opening heights by cabinet height. See cabinet and accessory sku box for additional details.

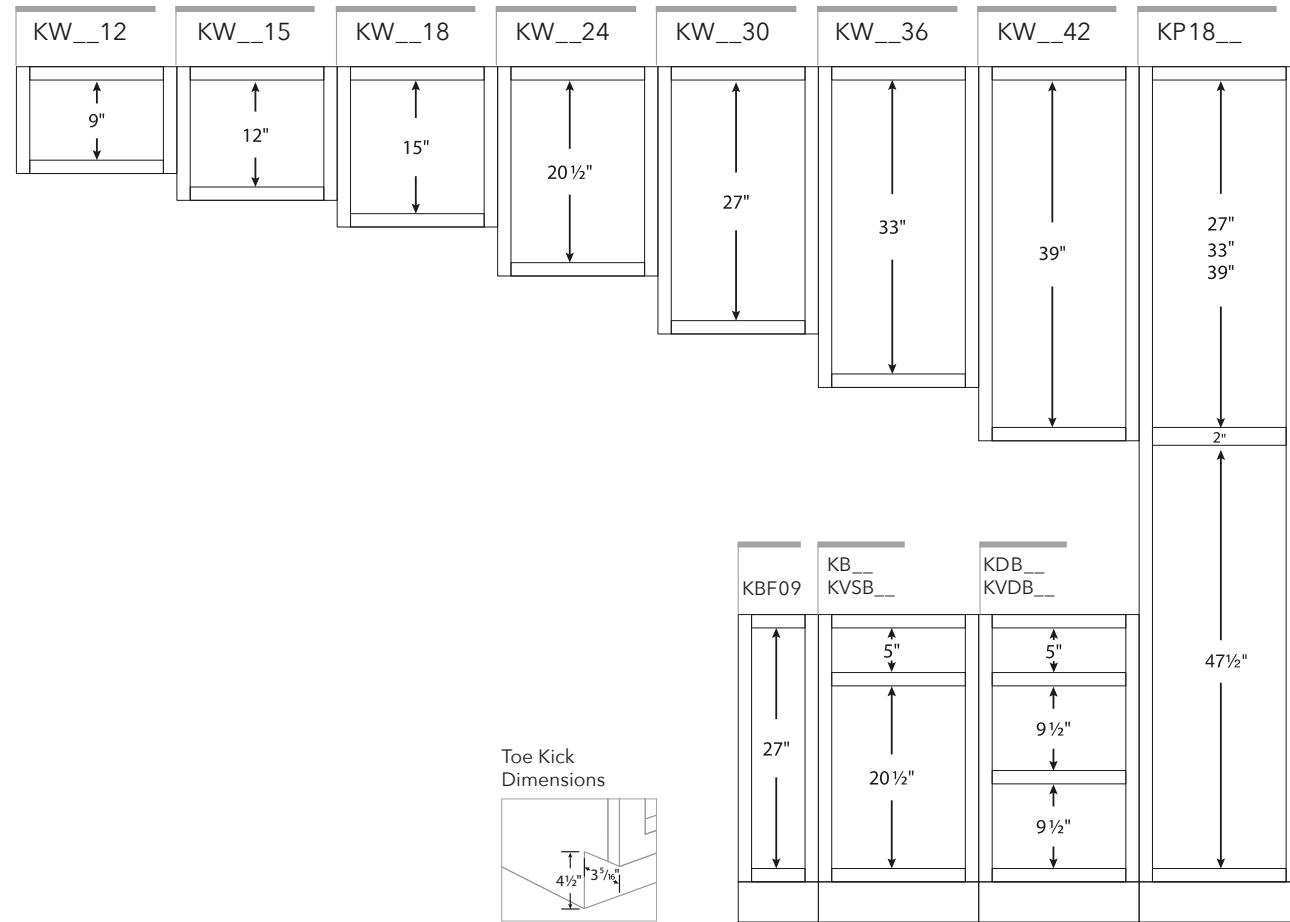

Ceiling Height Requirements for Tall Cabinets

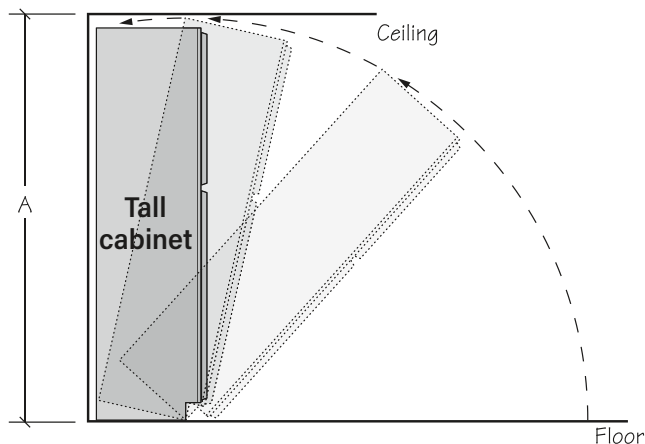

CABINET HEIGHT	CABINET DEPTH	MINIMUM CEILING HEIGHT A
84"	18"	85 1/4"
84"	24"	86 1/2"
90"	24"	92 3/8"
96"	24"	96"

Installation Height Guidelines

These illustrations specify dimensions of standard interior opening heights by cabinet height. See cabinet and accessory sku box for additional details.

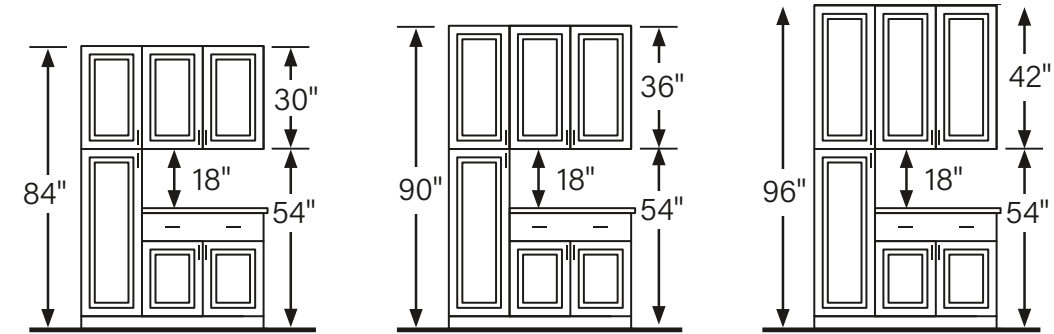

Notes:

- Tall cabinet and wall cabinet standard pairings for common top alignment design applications include:
 - 84" Top Alignment: 84" tall cabinets and 30" high wall cabinets
 - 90" Top Alignment: 90" tall cabinets and 36" high wall cabinets
 - 96" Top Alignment: 96" tall cabinets and 42" high wall cabinets
- Wall cabinets installed 54" above the finished floors per recommended pairings above allows for 18" of clearance between the wall cabinets and a standard countertop height of 36" - dimensions are for reference only, refer to local building codes for compliance.
- When selecting cabinetry for installation above or near any appliance, refer to the appliance manufacturer's specifications for clearance and venting requirements.

Additional Installation Height Considerations

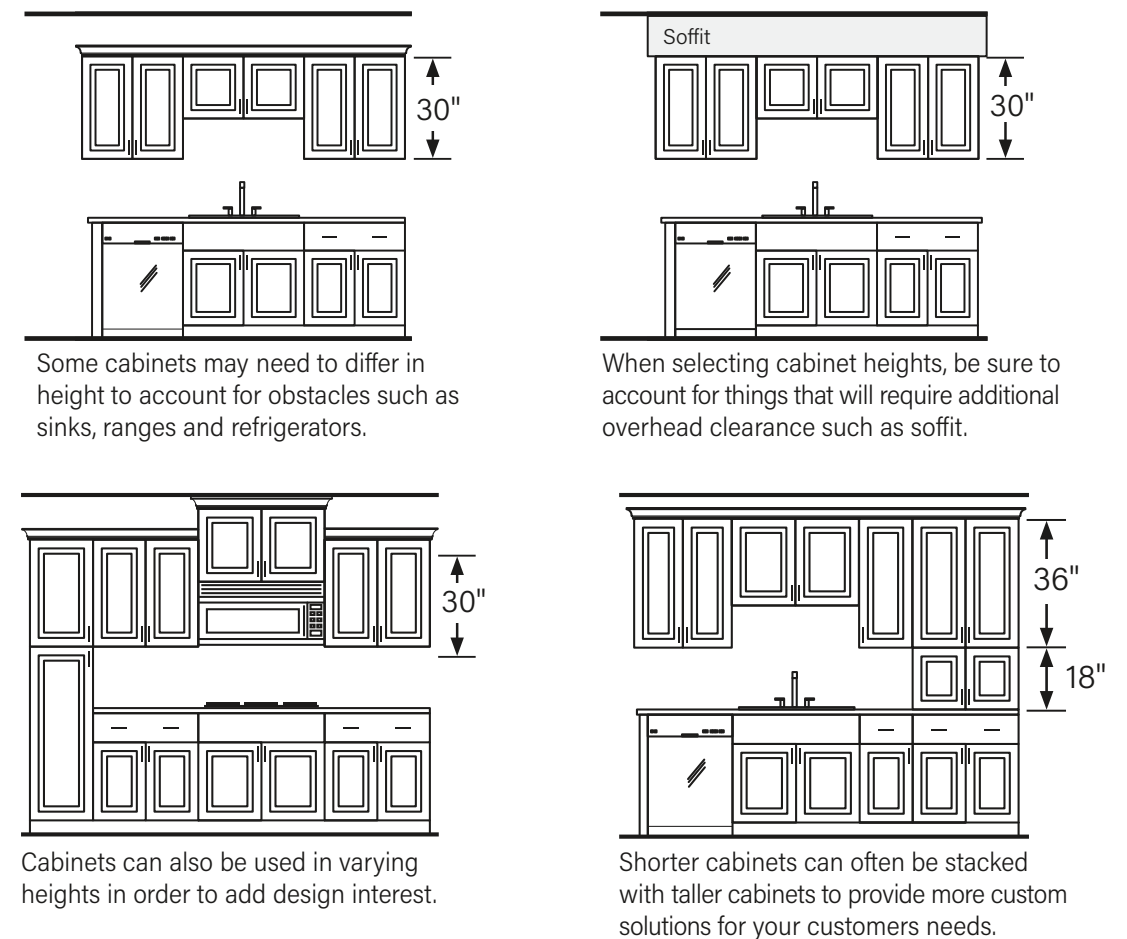

Finished and Unfinished Cabinetry

Model Number (as referenced online, in OrderUp or on Order Confirmations)

Model (as referenced in the Specification Guide and in 2020)

Door Style & Finish Code (see below)

KW 1230-NHK

Kitchen

Type of Cabinet or Accessory (see below)

Width (inches)

Height (inches)

TYPES OF CABINETS

TYPES OF ACCESSORIES

DOOR STYLES & FINISH CODES

NOTE: X at end denotes single pack through Special Order.

W	Wall/Wall Bridge Cabinet
WD	Corner Wall Cabinet
WFC	Wall Flex Cabinet
BF	Base Cabinet with Full Height Door
B	Base Cabinet
DB	Drawer Base Cabinet
SB	Sink/Cooktop Base Cabinet
CSB	Corner Sink Base Cabinet
SBA	Accessible Sink Base Cabinet
BBC	Blind Base Corner Cabinet
BLS	Lazy Susan Corner Base Cabinet
P	Pantry Cabinet
BW	Waste Bin Base Cabinet
WMS	Wall Flex Shelving
KAREP	Refrigerator End Panel
SBD	Apron Front Sink Base Cabinet
DV	Double Oven Cabinet
VSB	Vanity Sink Base Cabinet
VDB	Vanity Drawer Base

AS	Wall/Base Veneer End Panel
AIE	Island/Peninsula Veneer End Panel
AEP	Decorative Wall/Base End Panel
ADEP	Dishwasher End Panel
AUP	Universal Panel
ADPK	Decorative Island Panel Kit
ADCP	Decorative Corner Post
AFS	Filler
ADRTA	Base/Pantry Pull-Out Drawer
ATKX	Toe Kick Molding
AMTX	Quarter Round Molding
AMSX	Scribe Molding
AMC5X	Crown Molding - Traditional
AMC4X	Crown Molding - Shaker
AOCMX	Outside Corner Molding
AMBSX	Base Molding
AMSQX	Square Edge Molding
AMDEX	Decorative Edge Molding

NHK	Hampton Natural Hickory
MO	Hampton Medium Oak
SW	Hampton Satin White RTF
SJM	Shaker Java
SDV	Shaker Dove Gray RTF
SSW	Shaker Satin White RTF
SLO	Sinclair Light Oak
SSB	Sinclair Saddle Oak
UF	Unfinished

- Finish restrictions are indicated on models:**
- ◆ Only available in Finished
 - ◇ Only available in Unfinished
 - Only available for Shaker finishes, Sinclair finishes and Satin White Hampton
 - Only available for Hampton finishes, Satin White Shaker and Unfinished

2020 Suggestion:

When designing in 2020, be sure to select your door style and price level in order to get accurate pricing and important restriction alerts.



NEW! **PRODUCT** **NEW!** **SIZE** **NEW!** **UPDATE**

"NEW!" icons, as shown above, are used in combination with gray shading for easy identification of items that are newly available or updated in the Hampton Bay offering. Updated items will also include an "UPDATE" bullet to communicate changes that have occurred.

Wall Cabinets ▪ Single Door

NEW! **SIZE** **NEW!** **UPDATE**

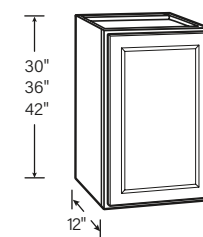

WIDTH	MODEL		
	30" HIGH	36" HIGH	42" HIGH
9"	KW930	KW936	—
12"	KW1230	KW1236	KW1242◆
15"	KW1530	KW1536	KW1542◆
18"	KW1830	KW1836	KW1842◆
21"	KW2130	KW2136	KW2142◆
24"	KW2430	KW2436	KW2442◆

NOTES

- ◆ Only available in Finished
- ALL DOOR STYLES:**
 - Reversible door for left or right hinging
- FINISHED DOOR STYLES:**
 - **UPDATE:** Previously restricted models now available in Light Oak and Saddle Oak
 - Includes two full-depth adjustable shelves
- UNFINISHED DOOR STYLES:**
 - Includes one full-depth adjustable shelf

Wall Cabinets ▪ Double Door

NEW! **SIZE** **NEW!** **UPDATE**

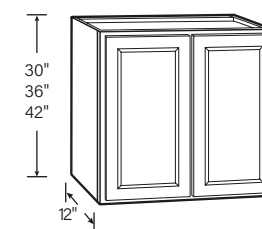

WIDTH	MODEL		
	30" HIGH	36" HIGH	42" HIGH
27"	KW2730	KW2736	KW2742◆
30"	KW3030	KW3036	KW3042◆
33"	KW3330◆	KW3336◆	KW3342◆
36"	KW3630	KW3636	KW3642◆

NOTES

- ◆ Only available in Finished
- FINISHED DOOR STYLES:**
 - **UPDATE:** Previously restricted models now available in Light Oak and Saddle Oak
 - Includes two full-depth adjustable shelves
- UNFINISHED DOOR STYLES:**
 - Includes one full-depth adjustable shelf

Design Suggestion:

Wall cabinets can be used as 12" deep base cabinets - a toe kick box should be built on site. In 2020 we have "Wall As Base" section in base cabinets that shows wall cabinets like this for quick designing!

Wall Bridge Cabinets ▪ 12" Deep & 15" Deep

NEW! **UPDATE**

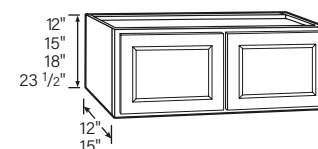

WIDTH	DEPTH	MODEL			
		12" HIGH	15" HIGH	18" HIGH	24" HIGH
30"	12"	KW3012	KW3015	KW3018	KW3024
30"	15"	—	—	—	KW302415
36"	12"	KW3612	KW3615	KW3618	KW3624

NOTES

- FINISHED DOOR STYLES:**
 - **UPDATE:** Previously restricted models now available in Light Oak and Saddle Oak
 - No shelf included on 12", 15" and 18" high cabinets
 - 24" high includes one full-depth adjustable shelf
- UNFINISHED DOOR STYLES:**
 - No shelf

Wall Bridge Cabinets ▪ 24" Deep

NEW! **UPDATE**

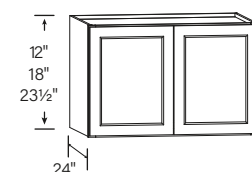

WIDTH	MODEL		
	12" HIGH	18" HIGH	24" HIGH
36"	KW361224◆	KW361824◆	KW362424◆

NOTES

- ◆ Only available in Finished
- FINISHED DOOR STYLES:**
 - **UPDATE:** Previously restricted models now available in Light Oak and Saddle Oak
 - Designed for use with Refrigerator End Panel
 - Each side of cabinet must be attached to a cabinet, wall or Refrigerator End Panel
 - No shelf included on 12" and 18" high cabinets
 - 24" high includes one full-depth adjustable shelf

Wall Bridge Cabinets • 12" Deep • 3 Doors

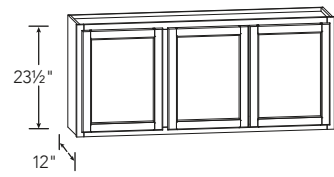

WIDTH	MODEL 24" HIGH	NOTES
54"	KW5424-UF	

◆ Only available in Unfinished and in-stock
UNFINISHED DOOR STYLES:
 • Includes one full-depth shelf

Corner Wall Cabinets • 12" Deep **NEW! UPDATE**

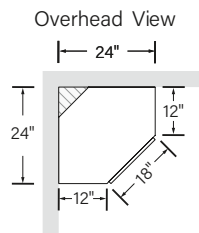
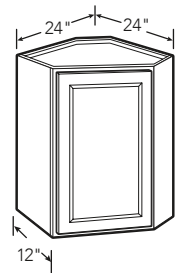

WIDTH	MODEL			NOTES
	30" HIGH	36" HIGH	42" HIGH	
30"	KWD2430	KWD2436	KWD2442	

◆ Only available in Finished
ALL DOOR STYLES:
 • Installs in a 24" x 24" wall area
 • Reversible door for left or right hinging
FINISHED DOOR STYLES:
 • **UPDATE:** Previously restricted models now available in Light Oak and Saddle Oak
 • 30" height includes one full-depth adjustable shelf
 • 36" and 42" heights includes two full-depth adjustable shelves
UNFINISHED DOOR STYLES:
 • Includes one full-depth adjustable shelf

Wall Flex Cabinets • 18" High **NEW! UPDATE**

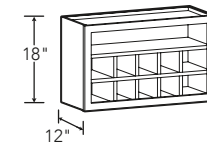

WIDTH	MODEL 18" HIGH	NOTES
30"	KWFC3018	

◆ Only available in Finished
FINISHED DOOR STYLES:
 • **UPDATE:** Previously restricted models now available in Light Oak and Saddle Oak
 • Includes open cabinet, two full-depth shelves, one 18" deep microwave shelf, eight dividers and dowels for multiple interior configurations
 • Shelves and dividers are pre-drilled for dowel placement
 • Features a matching interior

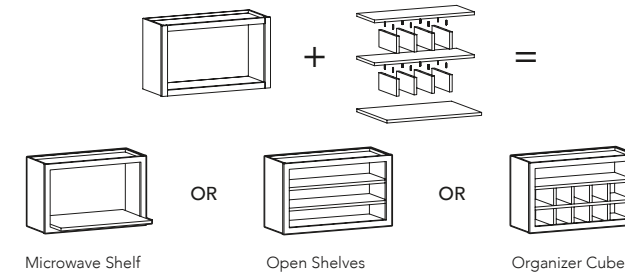

Design Suggestion:
 Wall Flex Cabinets can be used to enhance many of your designs. It can provide personalized storage solutions for your customer or function as a wall microwave shelf to free up more countertop space.

Wall Flex Shelving **NEW! UPDATE**

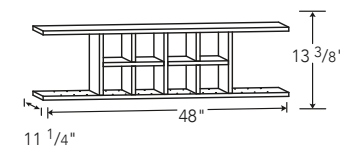

WIDTH	MODEL 13 3/8" HIGH	NOTES
48"	KWMS4813	

◆ Only available in Finished
FINISHED DOOR STYLES:
 • **UPDATE:** Previously restricted models now available in Light Oak and Saddle Oak
 • Includes top shelf, bottom shelf, five large shelf dividers, four small shelf dividers and dowels for multiple interior configurations
 • Shelves and dividers are pre-drilled for dowel placement
 • Can be trimmed to most widths under 48"
 • Ready to assemble
 • Features a matching interior

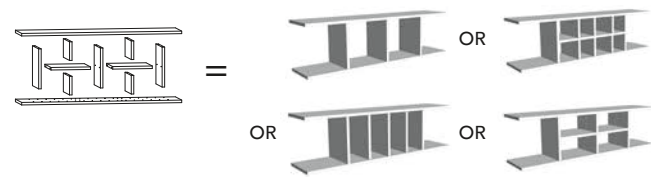

Design Suggestion:
 Wall Flex Shelves are ideal for wine, cookbooks or to showcase special items. For a built-in look, finish the installation with KAMSQX molding on the front of the shelf kit.

Wall Flex Cabinets • 30" High **NEW! UPDATE**

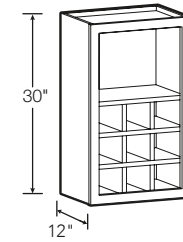

WIDTH	MODEL 30" HIGH	NOTES
18"	KWFC1830	

◆ Only available in Finished
FINISHED DOOR STYLES:
 • **UPDATE:** Previously restricted models now available in Light Oak and Saddle Oak
 • Includes open cabinet, three full-depth shelves, six dividers and dowels for multiple interior configurations
 • Shelves and dividers are pre-drilled for dowel placement
 • Features a matching interior

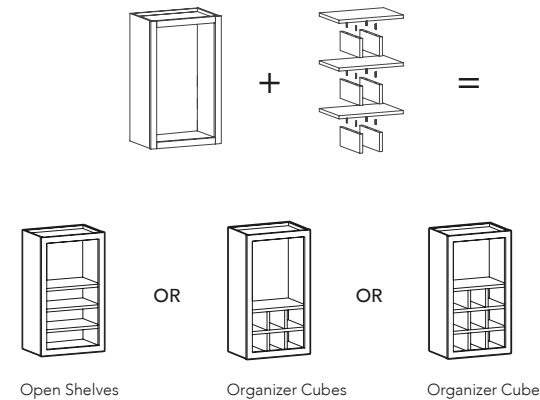

Design Suggestion:
 Wall Flex Cabinets are a great storage solution that gives customers the flexibility to meet many storage needs. They can be used as open shelves, storage cubes or a combination of both as shown here.

Base Cabinet • Full Height Door

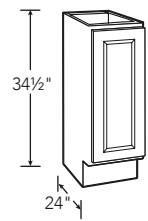

WIDTH	MODEL	NOTES
9"	KBF09	ALL DOOR STYLES: <ul style="list-style-type: none"> Includes one half-depth adjustable shelf Reversible door for left or right hinging

Base Cabinet • Single Door

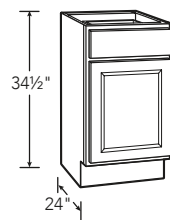

WIDTH	MODEL	NOTES
12"	KB12	ALL DOOR STYLES: <ul style="list-style-type: none"> Includes one half-depth adjustable shelf Reversible door for left or right hinging FINISHED DOOR STYLES: <ul style="list-style-type: none"> Ball-bearing drawer glides UNFINISHED DOOR STYLES: <ul style="list-style-type: none"> Epoxy drawer glides
15"	KB15	
18"	KB18	
21"	KB21	
24"	KB24	

Base Cabinet • Single Door with Double Wastebasket Pullout **NEW! PRODUCT**

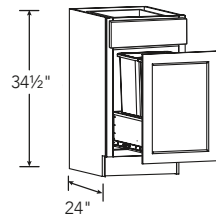

WIDTH	MODEL	NOTES
18"	KBWD18♦	♦ Only available in Finished FINISHED DOOR STYLES: <ul style="list-style-type: none"> Heavy-duty ball-bearing drawer glides Includes two 35 quart wastebaskets

Base Cabinet • Double Door **NEW! SIZE**

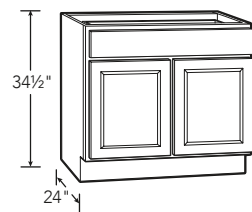

WIDTH	MODEL	NOTES
27"	KB27	♦ Only available in Finished ALL DOOR STYLES: <ul style="list-style-type: none"> Includes one half-depth adjustable shelf FINISHED DOOR STYLES: <ul style="list-style-type: none"> Ball-bearing drawer glides UNFINISHED DOOR STYLES: <ul style="list-style-type: none"> Epoxy drawer glides
30"	KB30	
33"	KB33♦	
36"	KB36	

Drawer Base Cabinet • 3 Drawers **NEW! UPDATE**

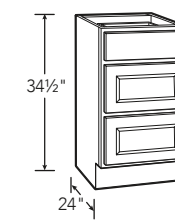

WIDTH	MODEL	NOTES
18"	KDB18	♦ Only available in Finished FINISHED DOOR STYLES: <ul style="list-style-type: none"> UPDATE: Previously restricted models now available in Light Oak and Saddle Oak Lower drawers feature 5-piece drawer front 18" and 24" widths feature ball-bearing drawer glides 30" and 36" widths feature full extension heavy duty drawer glides on all three drawers 30" and 36" widths are ideal for pots and pans UNFINISHED DOOR STYLES: <ul style="list-style-type: none"> All drawers feature slab drawer fronts Epoxy drawer glides
24"	KDB24	
30"	KDB30♦	
36"	KDB36♦	

Sink/Cooktop Base Cabinet **NEW! SIZE**

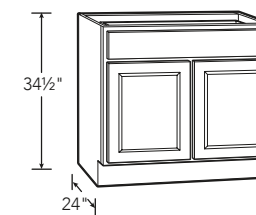

WIDTH	MODEL	NOTES
30"	KSB30	♦ Only available in Finished ALL DOOR STYLES: <ul style="list-style-type: none"> Features one top false drawer front Full-height back panel No shelf
33"	KSB33♦	
36"	KSB36	

36" Accessible Sink Base Cabinet **NEW! UPDATE**

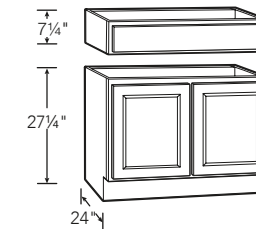

WIDTH	MODEL	NOTES
36"	KSBA36	ALL DOOR STYLES: <ul style="list-style-type: none"> Features one false drawer front on detachable cabinet header No shelf FINISHED DOOR STYLES: <ul style="list-style-type: none"> UPDATE: Previously restricted models now available in Light Oak and Saddle Oak Exterior side panels are natural maple laminate

36" Apron Front Sink/Cooktop Base Cabinet **NEW! UPDATE**

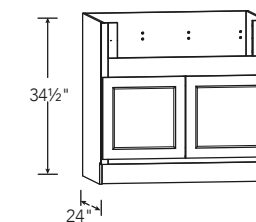

WIDTH	MODEL	NOTES	
36"	KSBD36♦	♦ Only available in Finished FINISHED DOOR STYLES: <ul style="list-style-type: none"> UPDATE: Previously restricted models now available in Light Oak and Saddle Oak 2" stiles and 4" rail are trimmable to accommodate various size sinks/cooktops Smaller size sinks/cooktops can be accommodated with use of 3" or 6" filler No shelf 	
APRON CUTOUT DIMENSIONS			
Actual Width	Max. Width	Actual Height	Max. Height
29"	33"	7 1/2"	11"

60" Sink/Cooktop Base Cabinet

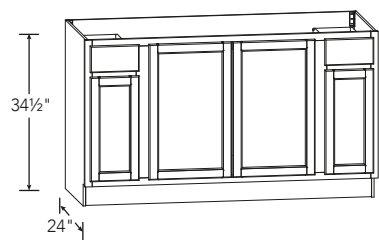

WIDTH	MODEL	NOTES
60"	KSBF60-UF	<ul style="list-style-type: none"> Only available in Unfinished and in-stock UNFINISHED DOOR STYLES: <ul style="list-style-type: none"> Features two top drawers Epoxy drawer glides Full-height back panel No shelf

Corner Base Cabinet with Lazy Susan

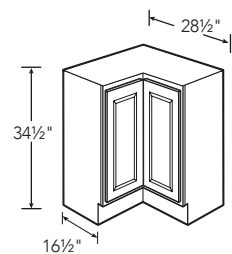

WIDTH	MODEL	NOTES
36"	KBLS36 KBLSN36-UF	<ul style="list-style-type: none"> Only available in Finished Only available in Unfinished and in-stock ALL DOOR STYLES: <ul style="list-style-type: none"> Installs in a 36" x 36" wall area FINISHED DOOR STYLES: <ul style="list-style-type: none"> Two-piece overlay door hinged together in the middle Two 360° independently rotating metal racks Exterior side panels are natural maple laminate UNFINISHED DOOR STYLES: <ul style="list-style-type: none"> Fixed traveling door rotates inside of cabinet Two plastic trays

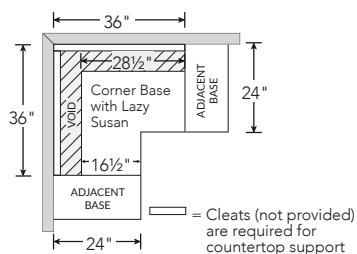

Corner Sink Base Cabinet NEW! UPDATE

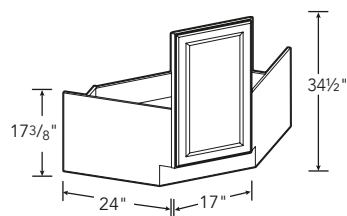

WIDTH	MODEL	NOTES
36"	KCSB36	<ul style="list-style-type: none"> ALL DOOR STYLES: <ul style="list-style-type: none"> UPDATE: Previously restricted models now available in Light Oak and Saddle Oak Ready to assemble Installs in a 36" x 36" area No shelf

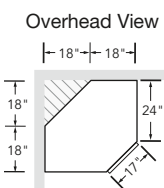

Blind Base Cabinet

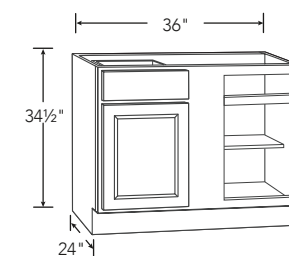

WIDTH	MODEL	NOTES
36"	KBBC45	<ul style="list-style-type: none"> ALL DOOR STYLES: <ul style="list-style-type: none"> Door and drawer are reversible to accommodate left or right blind FINISHED DOOR STYLES: <ul style="list-style-type: none"> Ball-bearing drawer glides Includes one half-depth adjustable shelf UNFINISHED DOOR STYLES: <ul style="list-style-type: none"> Epoxy drawer glides No shelf

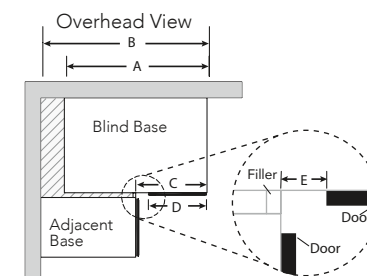

OVERLAY	CABINET WIDTH A	WALL SPACE		EXPOSED FRAME C*	DOOR WIDTH D	EXPOSED STILE E*
		MAX B	MIN B			
Full Overlay	36"	46 1/2"	40 1/8"	18"	14 3/4"	3 1/8"
Traditional Overlay	36"	46 1/2"	39 1/4"	18"	13"	4"
Unfinished	36"	46 1/2"	39 3/4"	18"	14"	3 1/2"

* Only applies when cabinet is pulled to 42"



Design Suggestion: How to Turn a Corner

Need suggestions on how to turn the corner in your design? There are many options to fit various space, design and budget needs. Here are some examples.

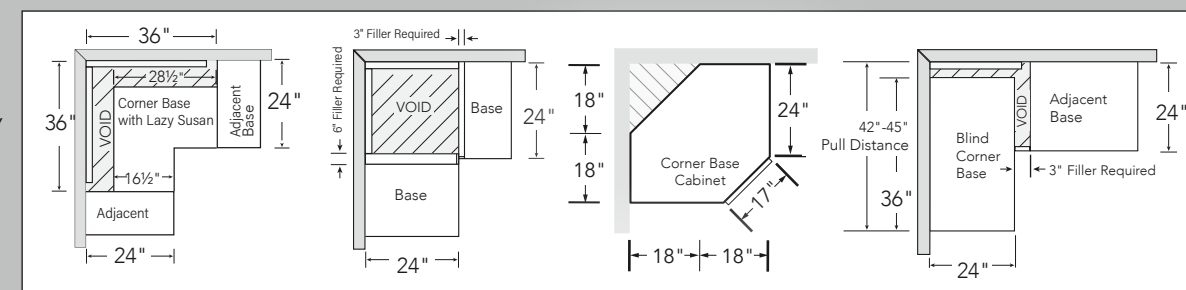

Vanity Cabinet - Double Doors

NEW! UPDATE

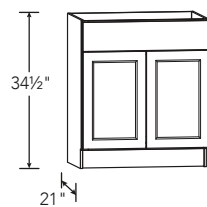

WIDTH	MODEL	NOTES
24"	KVSB24◆	◆ Only available in Finished FINISHED DOOR STYLES: • UPDATE: Previously restricted models now available in Light Oak and Saddle Oak • Features one top false drawer front • Works with standard toe kick (KATKX) sold separately • No shelf
30"	KVSB30◆	
36"	KVSB36◆	

Vanity Drawer Cabinet - 3 Drawers

NEW! UPDATE

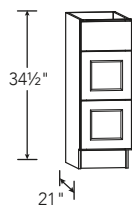

WIDTH	MODEL	NOTES
12"	KVDB12◆	◆ Only available in Finished FINISHED DOOR STYLES: • UPDATE: Previously restricted models now available in Light Oak and Saddle Oak • Lower drawers feature 5-piece drawer fronts • Works with standard toe kick (KATKX) sold separately • Ball-bearing drawer glides
15"	KVDB15◆	
18"	KVDB18◆	

Pantry - 24" Deep

NEW! UPDATE

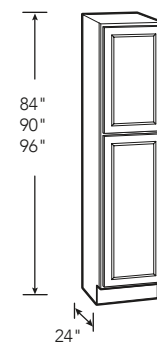

HEIGHT	MODEL 18" WIDE	NOTES
84"	KP1884	◆ Only available in Finished ALL DOOR STYLES: • Upper door lines up with 30", 36" and 42" high wall cabinets FINISHED DOOR STYLES: • UPDATE: Previously restricted models now available in Light Oak and Saddle Oak • 84" and 90" includes three full-depth adjustable shelves and one full-depth fixed shelf • 96" includes four full-depth adjustable shelves and one full-depth fixed shelf • 96" has removable toe kick that is field installed UNFINISHED DOOR STYLES: • Includes two full-depth adjustable shelves and one full-depth fixed shelf
90"	KP1890	
96"	KP1896◆	

Drawer Pantry - 18" Deep

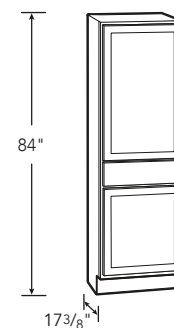

HEIGHT	MODEL	NOTES
84"	KPDR2484-UF◇	◇ Only available in Unfinished and in-stock UNFINISHED DOOR STYLES: • Upper door is height of tall pantry door • Bottom door is height of 24" high wall door • Includes two full-depth adjustable shelves for use in upper section • Features middle drawer with slab drawer front and epoxy drawer glides

Double Oven Cabinet

NEW! UPDATE

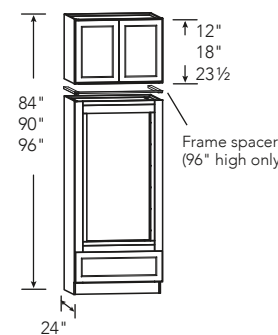

HEIGHT	MODEL 33" WIDE	NOTES
84"	KDV3384◆	◆ Only available in Finished FINISHED DOOR STYLES: • UPDATE: Previously restricted models now available in Light Oak and Saddle Oak • Overhead 24" Deep Bridge Cabinet is not pre-installed to oven cabinet, comes as two pieces, boxed separately • Lower drawer feature 5-piece drawer front and full-extension heavy-duty drawer glides • No shelf included for 84" and 90" high cabinets • 96" high features one full-depth adjustable shelf for use in overhead bridge cabinet • Rails and stiles around oven opening are trimmable to accommodate various size ovens • Can accommodate smaller size ovens with use of 3" and 6" filler • Frame spacer included in KDV3396 only
90"	KDV3390◆	
96"	KDV3396◆	

DOUBLE OVEN CUTOUT DIMENSIONS

Min. Width	Max. Width	Min. Height	Max. Height
24"	30"	47 5/8"	52 1/8"

24" Refrigerator End Panel Kit

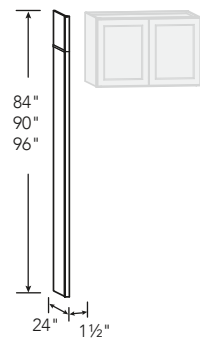

WIDTH	MODEL	NOTES
1 1/2"	KAREP◆	◆ Only available in Finished FINISHED DOOR STYLES: • Kit includes: one 84" high panel, one 12" high panel, one 6" high panel, one piece of scribe molding, 4 mending plates and 8 plate screws • Panels combine to achieve 84", 90" or 96" overall height • Features 1/2" panels finished on outside to match cabinet exterior • For use with 24" Deep Wall Bridge cabinets, must be secured to cabinet/wall studs to be secure

Design Suggestion:
 Refrigerator End Panel Kits include multiple panels that attach together for various height configurations. Simply combine them to meet your customers need.

Panel seam may be visible in some design scenarios, depending on height and panel placement, which can be concealed with included scribe molding.

Dishwasher End Panel

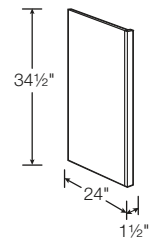

WIDTH	MODEL	NOTES
1 1/2"	KADEP	ALL DOOR STYLES: • Features 1/2" panels finished on outside to match cabinet exterior

Veneer End Panel NEW! UPDATE

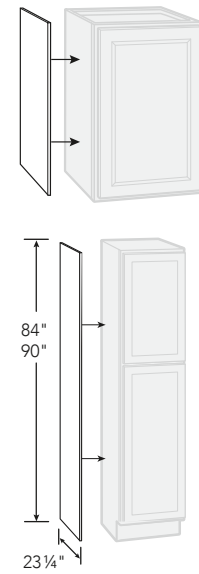

HEIGHT	MODEL					NOTES
	11 1/4" WIDE		23 1/2" WIDE		48" WIDE	
	FINISHED QTY 2	UNFINISHED QTY 1	FINISHED QTY 2	UNFINISHED QTY 1	FINISHED QTY 1	
30"	KAS1230◆	KASKW30-UF◇	—	—	—	◆ Only available in Finished ◇ Only available in Unfinished FINISHED DOOR STYLES: • UPDATE: Previously restricted models now available in Light Oak and Saddle Oak • Finished on one side to match cabinet exterior • All finishes, excluding Satin White and Dove Gray, feature 3/16" thick veneer panels • Satin White and Dove Gray finishes feature 3/16" thick laminate panels UNFINISHED DOOR STYLES: • Features 1/8" thick veneer panel
36"	KAS1236◆	KASKW36-UF◇	—	—	—	
42"	KAS1242◆	—	—	—	—	
34 1/2"	—	—	KAS2435◆	KASKB35-UF◇	KAIE4835X◆	
84"	—	—	—	KASKB84-UF◇	—	
90"	—	—	—	KASKB90-UF◇	—	

Decorative End Panel NEW! UPDATE

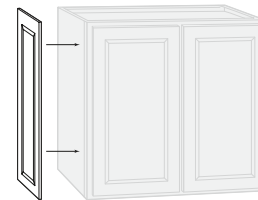

WIDTH	MODEL			NOTES
	30" HIGH	36" HIGH	42" HIGH	
12"	KAEP1230◆	KAEP1236◆	KAEP1242◆	◆ Only available in Finished FINISHED DOOR STYLES: • UPDATE: Previously restricted models now available in Light Oak and Saddle Oak • Matches style and finish of cabinet doors
15"	KAEP1530◆	—	—	
18"	KAEP1830◆	—	—	
24"	KAEP2430◆	—	—	

Decorative Corner Post

NEW! UPDATE

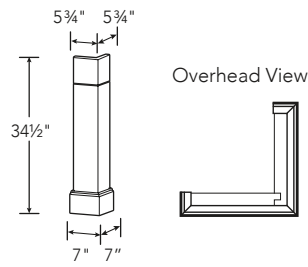

WIDTH	MODEL	NOTES
7"	KADCP6◆	◆ Only available in Finished FINISHED DOOR STYLES: • UPDATE: Previously restricted models now available in Light Oak and Saddle Oak • Features bottom molding on front and side surfaces • Features single groove detail 5 3/4" from top of post

Ready to Assemble Pull Out Drawer

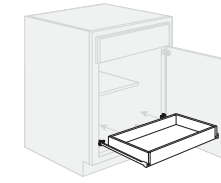

CABINET WIDTH	PULL OUT DRAWER WIDTH	MODEL	NOTES
12"	7"	KADRTA12◆	◆ Only for use in Finished cabinets listed in this Specification Guide FINISHED DOOR STYLES: • Kit includes natural maple laminate finish pull out drawer and all installation hardware • For use inside of 24" deep cabinets UNFINISHED DOOR STYLES: • Not designed for use inside Unfinished cabinets
15"	10"	KADRTA15◆	
18"	13"	KADRTA18◆	
21"	16"	KADRTA21◆	
24"	19"	KADRTA24◆	
27"	22"	KADRTA27◆	
30"	25"	KADRTA30◆	

Decorative Island Panel Kit

NEW! UPDATE

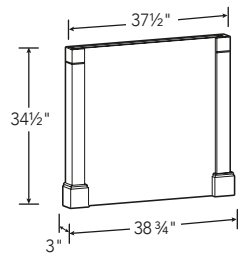

WIDTH	MODEL	NOTES
38 3/4"	KADPK337◆	◆ Only available in Finished FINISHED DOOR STYLES: • UPDATE: Previously restricted models now available in Light Oak and Saddle Oak • Kit ships with one corner post attached and one corner post unattached for field install • Panel width can be trimmed prior to field installing second corner post

Wall & Base Filler

NEW! UPDATE

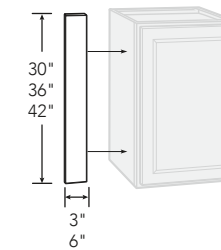

HEIGHT	3" MODEL		6" MODEL		NOTES
	SINGLE	MASTER PACK	SINGLE	MASTER PACK	
30"	KAFS330X	KAFS330◆	KAFS630X	KAFS630◆	◆ Only available in Finished ALL DOOR STYLES: • UPDATE: Previously restricted models now available in Light Oak and Saddle Oak • 3/4" thick • Single pack fillers are sold through Special Order, Master packs include 5 fillers
36"	KAFS336X	KAFS336◆	KAFS636X	KAFS636◆	
42"	KAFS342X◆	—	KAFS642X◆	—	

91 1/2" Pantry Filler

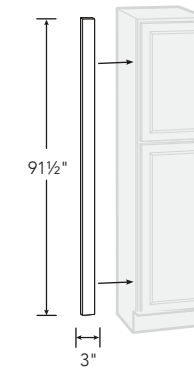

HEIGHT	3" MODEL		NOTES
	SINGLE	MASTER PACK	
91 1/2"	KAFS396X	KAFS396◆	◆ Only available in Finished ALL DOOR STYLES: • For use with 96" high cabinets, can be field trimmed for use with 90" or 84" high cabinets • 3/4" thick • Single pack fillers are sold through Special Order, Master packs include 5 fillers

91 1/2" Toe Kick Molding

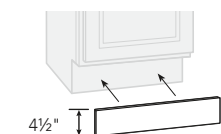

HEIGHT	MODEL		NOTES
	SINGLE	MASTER PACK	
4 1/2"	KATKX	KATK◆	◆ Only available in Finished ALL DOOR STYLES: • Single pack fillers are sold through Special Order, Master packs include 5 toekick FINISHED DOOR STYLES: • All finishes, excluding Satin White and Dove Gray, feature 3/16" thick veneer panels • Satin White and Dove Gray finishes feature 3/16" thick laminate panels UNFINISHED DOOR STYLES: • Features 1/8" thick veneer panel



Design Suggestion:

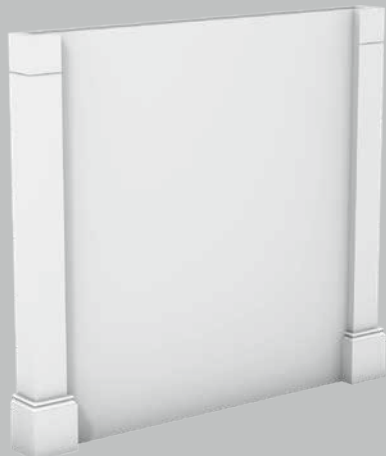

A great way to maximize storage or work space, island panels are a fast and easy way to build an island or a peninsula.

One post is shipped loose to allow the panel to be trimmed.

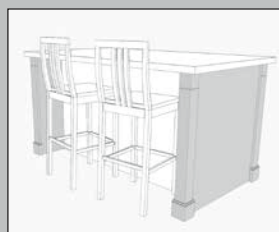

Island with Seating

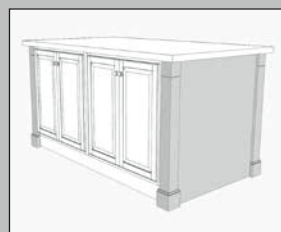

Island with Wall Cabinets



Base Depth Island

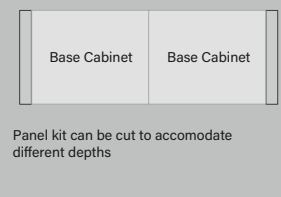
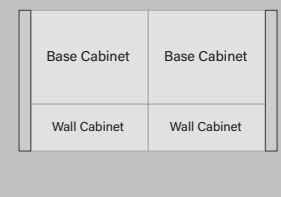
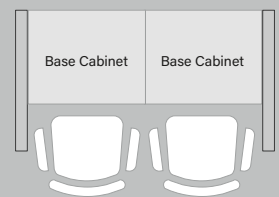

Panel kit can be cut to accommodate different depths



Peninsula Seating Area
Panel kit can be used with the proper countertop supports

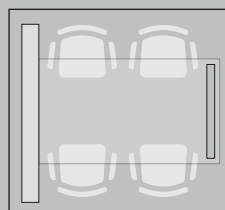

Use one decorative island panel to create a roomy peninsula for a convenient eating area in the kitchen.

Universal Panel

NEW! UPDATE

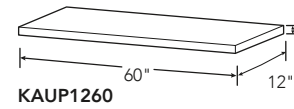
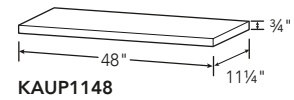

WIDTH	MODEL	
	SINGLE	MASTER PACK
48"	KAUP1148	KAUP1148
60"	KAUP1260	KAUP1260

◆ Only available in Finished
FINISHED DOOR STYLES:
 • **UPDATE:** Previously restricted models now available in Light Oak and Saddle Oak
 • Laminated engineered wood finish on top, bottom, two short edges and one long edge

Design Suggestion:

48" x 11-1/4" Universal Panel

60" x 12" Universal Panel

Decorative Edge Molding

Square Edge Molding

Span Open Spaces

Build Custom Features

Stacked Crown

Universal Panel with Edge Molding

Universal Panel with Edge Molding

Use Universal Panels to add affordable shelf space and accent storage in any room. Available in two sizes, they can be used in vertical or horizontal applications and combined with edge molding for a decorative accent.

91 1/2" Molding

NEW! UPDATE

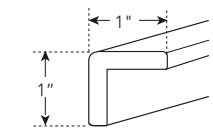

KAOCMX - Outside Corner

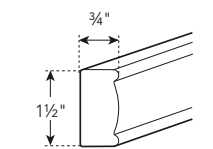

KAMDEX - Decorative Edge

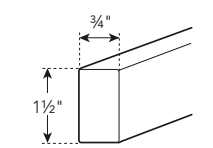

KAMSQX - Square Edge

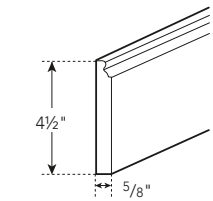

KAMBSX - Base

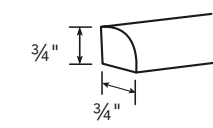

KAMTX - Quarter Round

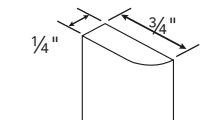

KAMS/KAMSX - Scribe

DESCRIPTION	MODEL	
	SINGLE	MASTER PACK
OUTSIDE CORNER	KAOCMX	—
DECORATIVE EDGE	KAMDEX	—
SQUARE EDGE	KAMSQX	—
BASE	KAMBSX	—
QUARTER ROUND	KAMTX	—
SCRIBE	KAMSX	KAMS

◆ Only available in Finished
ALL DOOR STYLES:
 • **UPDATE:** Previously restricted models now available in Light Oak and Saddle Oak
 • Decorative Edge and Square Edge moldings can be used as light rail molding - cleating may be needed for install
 • Single pack moldings are sold through Special Order, Master packs include 12 moldings

Design Suggestion:

Scribe molding is great for trimming around cabinets to cover gaps where walls might have uneven gaps or raw edges are visible on items that have been field trimmed.

Similar to Scribe, Quarter Round molding is often used as a transition from toe kick moldings to the floor to help cover any uneven gaps in the flooring and provide a more finished look.

91 1/2" Crown Molding

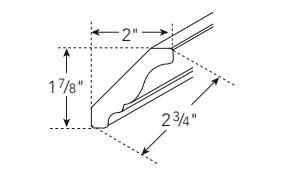

KAMC5X - Traditional

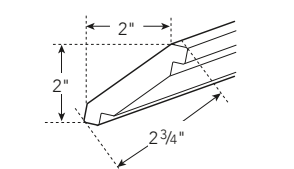

KAMC4X - Shaker

DESCRIPTION	MODEL	
	SINGLE	MASTER PACK
TRADITIONAL	KAMC5X	KAMC5
SHAKER	KAMC4X	KAMC4

◆ Only available for Hampton finishes, Satin White Shaker and Unfinished (excluding KAMC5 Master Pack in Unfinished)
 ■ Only available for Shaker finishes, Sinclair finishes and Satin White Hampton
ALL DOOR STYLES:
 • Single pack moldings are sold through Special Order, Master packs include 6 moldings
 • Shaker molding (KAMC4X) is designed to complement the Shaker and Sinclair door styles - available for all Shaker and Sinclair finishes
 • Traditional molding (KAMC5X) is designed to complement the Hampton and Unfinished door styles - available for all Hampton finishes and Unfinished
 • Shaker and Traditional moldings are available in Satin White for both Shaker and Hampton door styles
 • See Design Suggestion above for stacked molding example

All Finished Cabinetry : Limited Lifetime Warranty
All Unfinished Cabinetry : 1 Year Limited Warranty

What This Warranty Covers: American Woodmark Corporation, the manufacturer of Hampton Bay, warrants its parts and products to be free of substantial defects in materials and workmanship from the original date of purchase under normal home use. This warranty is offered only to the original consumer purchaser and may not be transferred.

What Hampton Bay Will Do Under The Warranty: During the warranty period, the manufacturer of Hampton Bay will repair or replace any part or product that proves to have substantial defects in materials or workmanship, or the manufacturer of Hampton Bay will provide an equivalent replacement product. In keeping with our policy of continuous product improvement, the manufacturer of Hampton Bay reserves the right to change specifications in design and materials without notice and with no obligation to retrofit products we previously manufactured.

How State Law Applies: This warranty gives you specific legal rights, and you may also have other rights that vary from state to state.

Implied Warranties: The manufacturer of Hampton Bay disclaims any implied warranty of merchantability, and there are no warranties that extend beyond the descriptions on the face hereof. To the extent that such disclaimer is not valid under applicable law, any implied warranty shall be coextensive in duration with this warranty.

Wood Characteristics, Aging and Printing Limitations: Because of the varying natural characteristics of wood and the effects of aging, product shown in displays and/or printed materials will not be an exact match to new cabinetry you will receive. Depending on the wood characteristics, the age of a sample and the environment of the showroom, samples will show some degree of variation from new product. In addition, you should not expect all doors, drawer fronts, trim or molding to match exactly in either finish or grain. Variation in wood is normal and unavoidable. In addition, it is not possible to exactly match our colors in printed materials. Therefore, you should view the actual samples when making your color selection.

What This Warranty Does Not Cover: This warranty does not cover any problems or damage which result from improper transportation, improper installation, mishandling, misuse, abuse, neglect, abnormal use, commercial use, improper maintenance, non-Hampton Bay repairs, accidents, or acts of God, such as hurricanes, fire, earthquakes or floods. This warranty and any applicable implied warranties do not cover incidental or consequential damages arising from any defects in the product, such as labor charges for installation or removal of the product or any associated products. This warranty does not cover defects or damage caused by normal wear & tear, alterations, environmental conditions, humidity absorption, or mold. In addition, variations in wood grain, finish color, aging or other natural wood and stain characteristics are not considered defects and are not covered by this warranty. Some states do not allow the exclusion or limitation of incidental or consequential damages, so the above limitation or exclusion may not apply to you.

How to Obtain Warranty Service: If you need replacement parts or would like to make a warranty claim, please contact Hampton Bay Customer Care at (888) 578-4009. All warranty claims must include the model number of the product, copy of the original receipt and the nature of the problem. In addition, the manufacturer of Hampton Bay may at its discretion require inspection of the installation site or authorize the prepaid return of the claimed defective part. Merchandise not pre-approved for return will not be accepted and the associated claim not accepted.

Products should be examined for defects prior to installation. This warranty also does not cover labor charges for installation or removal of the product or any associated products. If upon inspection you find our product has a damaged or missing part, it may not be necessary to return the unit to the store of purchase. Please contact Hampton Bay Customer Care to possibly obtain a replacement part.

Care and Cleaning

- For normal spills, a damp cloth is sufficient. Remember to dry the surface immediately.
- Thermofoil (RTF) doors can be cleaned with most general purpose household cleaners.
- Wood doors can be cleaned with most general purpose household cleaners and polished with most furniture care products, not containing wax, petroleum solvents or silicones.
- Do not use caustic agents and/or abrasive scrubbers, or oven cleaners.
- Nicks and dings can be repaired with touch-up kits, available by calling Hampton Bay Customer Care at (888) 578-4009.
- For stains that persist, flakes of Ivory soap diluted in warm water may be used with a cloth or sponge. Remember to dry the surface immediately.
- Do not let liquids stay on the surface for a long period of time. The surface is water resistant, not waterproof.

Repairing Door or Drawer Edge Scrapes

Use touch-up sticks available by calling Hampton Bay Customer Care at (888) 578-4009 to fill in a scratch or nick. Remove excess residue leaving a smooth surface.

Important Health Notice:

Some of the building materials used in this home (or these building materials) emit formaldehyde. Eye, nose, and throat irritation, headache, nausea and a variety of asthma-like symptoms, including shortness of breath, have been reported as a result of formaldehyde exposure. Elderly persons and young children, as well as anyone with a history of asthma, allergies, or lung problems, may be at greater risk. Research is continuing on the possible long-term effects of exposure to formaldehyde.

Reduced ventilation may allow formaldehyde and other contaminants to accumulate in the indoor air. High indoor temperatures and humidity raise formaldehyde levels. When a home is to be located in areas subject to extreme summer temperatures, an air-conditioning system can be used to control indoor temperature levels. Other means of controlled mechanical ventilation can be used to reduce levels of formaldehyde and other indoor air contaminants.

If you have any questions regarding the health effects of formaldehyde, consult your doctor or local health department.

WARNING: This product can expose you to chemicals including formaldehyde, which is known to the State of California to cause cancer, and methanol, which is known to the State of California to cause birth defects or other reproductive harm. For more information go to www.P65Warnings.ca.gov/products.

Manufacturer:	American Woodmark Corporation	Customer Care Service Hours:	Monday through Friday 8:00 am - 7:00 pm EST
In-Stock Vendor #:	71203	Home Depot Customer Support #:	(877) 527-0313
Special Order Vendor #:	60071203	Hampton Bay Customer Care #:	(888) 578-4009
Pro Program Vendor #:	60081766	Order Processing Fax #:	(714) 449-2222
Delivery Fee to Store:	NONE	Customer Care Email:	homeproducts_CC@woodmark.com
Visit us at:	www.hamptonbaykitchens.com		

Copyright © 2024 American Woodmark Corporation®. All rights reserved. THE HOME DEPOT® is a registered trademark of Homer TLC, Inc. HAMPTON BAY® is a registered trademark of Home Depot Product Authority, LLC.

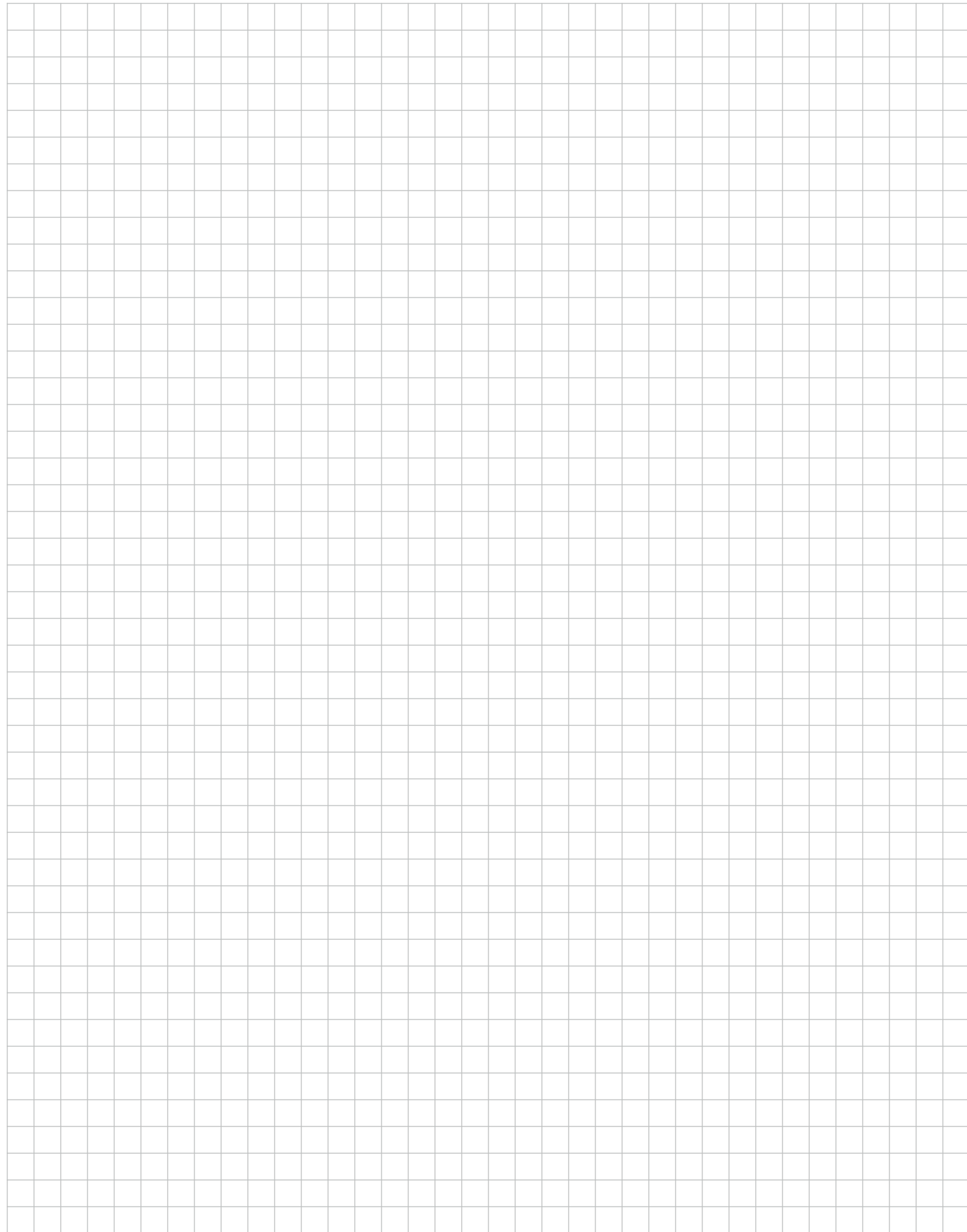

HAMPTON BAY

SHAKER



Satin White RTF



Dove Gray RTF



Java

SINCLAIR



Light Oak



Saddle Oak

HAMPTON



Satin White RTF



Natural Hickory

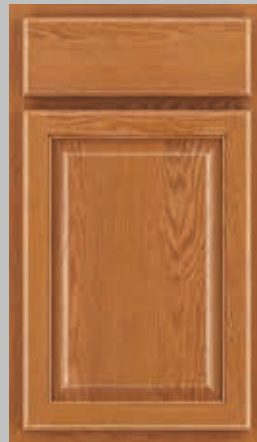

Medium Oak

UNFINISHED



Unfinished

All Hampton Bay® products meet or exceed the stringent performance requirements established by the Kitchen Manufacturers Association (KCMA). The KCMA Performance & Construction Standards ANSI/KCMA A161.1 is recognized and overseen by the American National Standards Institute. This standard also meets the HUD specification 4910.1 Paragraph 611-1.1, Minimum Property Standards for Housing.

Finished Cabinetry



Unfinished Cabinetry

